

SMU-9000

EC DECLARATION OF CONFORMITY

This apparatus, when installed and operated per the manufacturer's recommendations, conforms with the protection requirements of EC Council Directive 89/336/EEC on the approximation of the laws of the member states relating to Electromagnetic Compatibility, as required by the Technical Construction File Route to Conformity.

The Certificate has been issued in accordance with the conditions of regulation No. 53 of the U.K. Statutory Instruments 1992 No: 2372 - The Electromagnetic Compatibility Regulations.

**DO NOT MAKE ANY MODIFICATIONS TO CABLE LENGTH, SENSOR
OR CALIBRATED TARGET MATERIALS WITHOUT PRIOR
CONSULTATION WITH A KAMAN APPLICATION ENGINEER**

PROPRIETARY INFORMATION

Any reproduction, disclosure or other use of this information is expressly prohibited except as Kaman Precision Products may otherwise agree to by writing.

Part IX: Warranty

Kaman Precision Products Standard Limited Warranty

Products of Kaman Precision Products are warranted to be free from defects in materials and workmanship when installed and operated in accord with instructions outlined in the instruction manual.

Kaman Precision Products' obligation under this warranty shall be limited to repair or replacement (at the discretion of Kaman Precision Products of the defective goods returned to Kaman's plant within one (1) year from date of shipment. Extreme environment sensors are limited to the maximum operating temperature as specified within the most current Kaman Precision Products Extreme Environment Systems data sheets.

This warranty is valid except when the products have been subject to misuse, accident, negligent damage in transit or handling, or operation outside the conditions prescribed in the data sheet or instruction manual. This will be determined by Kaman Precision Products personnel.

In no event shall Kaman be liable for incidental or consequential damages, including commercial loss, resulting from any article sold under this Agreement.

In the event Buyer fails to limit to Kaman's warranty set forth above, any express or implied warranty Buyer may make with respect to any product of which any article sold thereunder is a component, Buyer shall indemnify and hold Kaman harmless from any and all liability, costs and expenses to which Kaman may be subjected as a result of Buyer's failure to so limit its express or implied warranties.

THIS WARRANTY IS EXCLUSIVE AND IS MADE IN LIEU OF ALL OTHER WARRANTIES; AND THOSE IMPLIED WARRANTIES, INCLUDING SPECIFICALLY THE WARRANTIES OR MERCHANTABILITY AND FITNESS FOR A PARTICULAR PURPOSE ARE HEREBY EXPRESSLY LIMITED TO ONE (1) YEAR DURATION.

NO MODIFICATION OR ALTERATION OF THE FOREGOING WARRANTY AND LIMITATION OR REMEDIES PROVISIONS SHALL BE VALID OR ENFORCEABLE UNLESS SET FORTH IN A WRITTEN AGREEMENT SIGNED BY KAMAN AND THE BUYER.

Kaman Precision Products Warranty No. 7A

Part I: Welcome

Introduction

Ka SMU-9000 measuring systems use inductive (eddy current) technology to measure position without contacting the target. SMU-9000 measuring systems are ideally suited for applications requiring high resolution and economical performance-to-price ratio. Based on Kaman's proprietary *Pulse Width Modulated* electronics, the SMU-9000 systems incorporate the latest surface-mount components with printed circuit board designs. The use of pulse width modulation techniques virtually eliminates the noise of traditional linear amplifiers, thereby "unmasking" position/motion sensing down into sub-atomic dimensions. This technology requires only simple, single ended supply voltage and low power circuitry.

Features Summary / Advantages

- Extremely high resolution, to 1 Å
- Signal-to-noise ratio: 1 PPM
- Precision of 0.1% of full scale, using computer correction.
- Small size for efficient system integration: 2 channels in less than 5.5 cubic inches (91cc)
- Flexible packaging and performance.
- Multiple configurations available: 9000 single channel, 9200 dual or balanced differential operation, and three and four channel models.
- Wide range of sensor options.
- Low power consumption: less than 40 mW per channel.

The SMU-9000

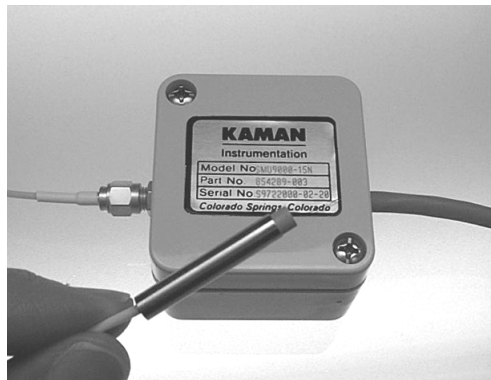

Figure 1. Single Channel SMU-9000.(Poly-carbonate Enclosure shown)

SMU-9000 Configurations

The SMU-9000 measuring system is available in several configurations. These configurations include: Single Channel, Dual Channel, Three Channel, and Four Channel systems shown in figures 2 through 4. The system electronics is housed in an enclosure made of die cast aluminum or poly-carbonate material. Sensors for the SMU-9000 come in a wide variety. The selection of a specific sensor is dependent upon the application in which the system is used.

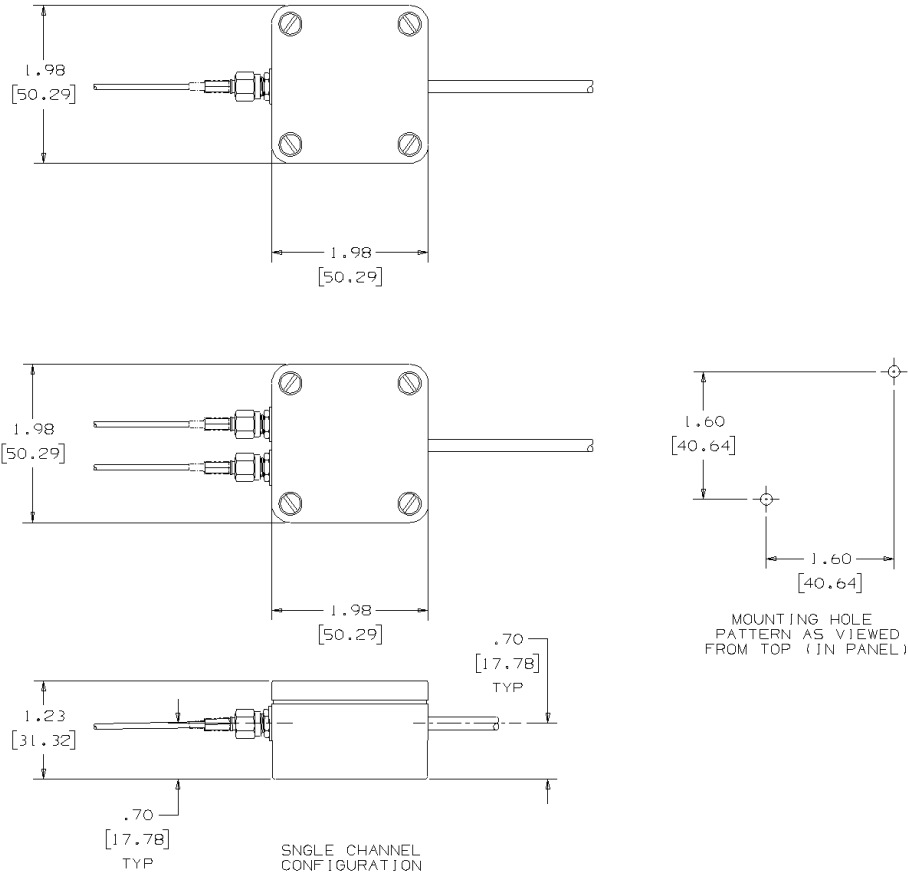

Figure 2. Outline Drawing, Single and Dual Channel SMU-9000

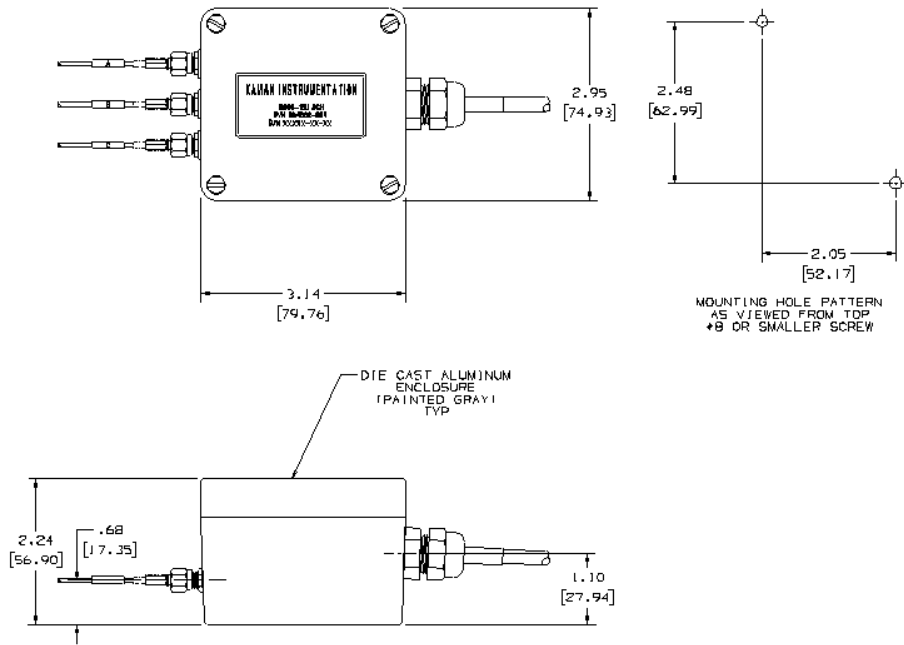

Figure 3. Outline Drawing, 3 Channel SMU-9000

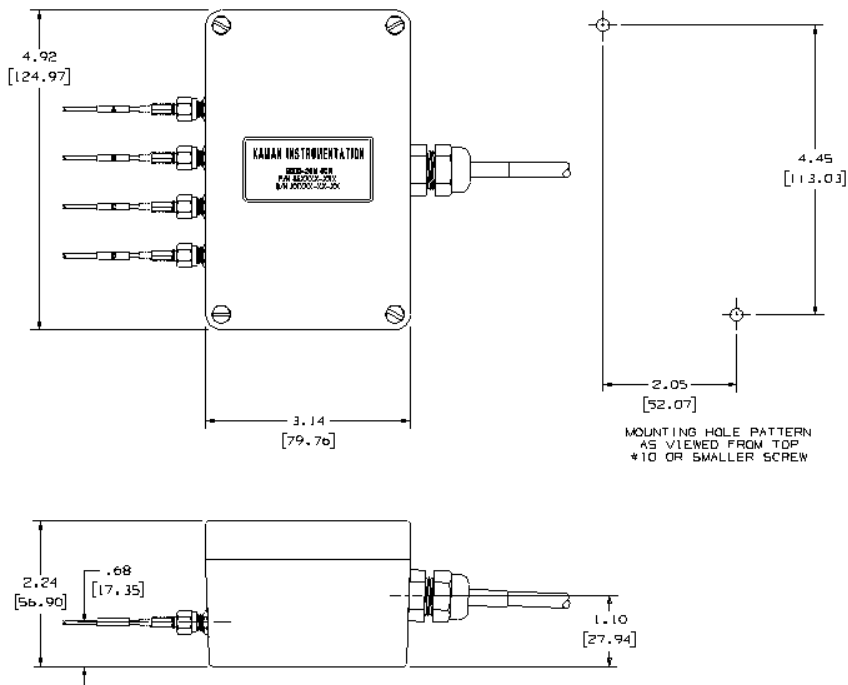

Figure 4. Outline Drawing, 4 Channel SMU-9000

Part II: Setting Up the System

Power Supply Requirements

The critical circuit voltages needed for operation of the SMU-9000 are internally regulated. Therefore, any single ended DC voltage power supply which can furnish from 6.5 to 30 volts at 20ma per channel may be used.

Note: Avoid using switching power supplies if high resolution (low noise) output is required.

The output amplifier runs directly from the supply voltage (positive) and an internally generated negative voltage. The system can be calibrated to have an output voltage swing anywhere from -5 volts to within 1.5 volts below the supply voltage. Typical output voltage ranges and the required input supply voltages are as follows:

Output Voltage Range	Required Input Supply Voltage
-5 Vdc to +5 Vdc	Requires a minimum 6.5 Volt supply
0 Vdc to +10 Vdc	Requires a minimum 11.5 Volt supply
0.2 Vdc to 3.5 Vdc	Requires a 5 Volt supply and special 3.5 Volt internal regulator to achieve minimum power drain of 40 mW per channel
-10 Vdc to +10 Vdc balanced differential	Requires differential SMU-9200 with ± 5 Volt output from each channel and a minimum 6.5 Volt supply

Table 1. Output Voltage Range and Required Input Voltages for the SMU-9000

Power and Output Connections

The standard SMU-9000 power and output connection consists of a one meter long shielded four-wire cable. The power and output (P/O) wires are labeled accordingly. Connect the labeled power wires from the SMU-9000 to the appropriate input supply voltage that will be used. For example, the wire labeled “Positive Supply Lead” on the SMU-9000 should be connected to the positive supply voltage of the power source and the wire labeled “Negative Supply Lead” should be connected to the negative supply voltage of the power source.

Note: The power supply source being used should be turned off when connecting the power and output wires of the SMU-9000 so as to avoid accidentally shorting the system to ground.

If additional power and output cable lengths are added, or if multiple units are connected to a common supply, it is recommended that separate cable wires be provided for supply and output leads to maintain maximum resolution. It should also be noted that the most common limitations on signal resolution are mechanical vibrations (microphonics) of sensor/target configurations.

SMU-9200 System

The SMU-9200 dual channel differential systems have a six conductor shielded power and output cable providing separate wires for supply and signal return leads. These, along with the sensor coax shields are all at a common internal “ground” potential. In addition, each channel’s amplifier has a 100 ohm output impedance. When operated as a differential system (“balanced to ground” output taken from the two + labeled wires), a common mode rejection of noise and “hum” is achieved by connecting into a differential input device.

Output Wires

The output wires are labeled “Positive Signal Output” and “Negative Signal Output Return”. The output wires can be connected to a voltmeter, oscilloscope, or data acquisition system in order to display actual displacement in volts. Connect the Positive Signal Output wire to the Positive terminal and the Negative Signal Output Return to the common terminal.

Sensor Installation

The sensor(s) for the SMU-9000 is connected to the electronics via an SMA type connector (other types of connectors are available upon request). Connect the sensor to the unit and mount the sensor on a stable platform. Since target motion is usually the desired measurement, be sure the sensor mount provides a stable reference. A Kaman micrometer fixture is recommended (Part no.: 850854-001). A sensor installation for a standard calibration is shown below.

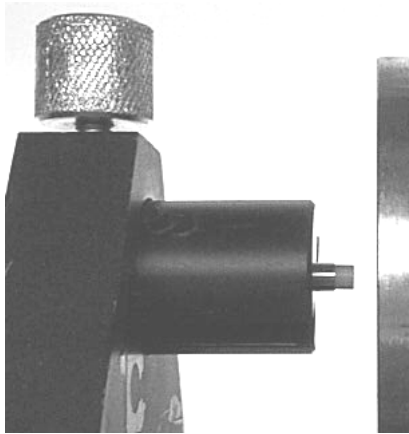

Figure 5. Sensor Installation

When mounting the sensor, an offset region should be included in addition to the measurement range desired. The offset is the minimum space or gap between the sensor and target. The sensor should be positioned so that the target never enters this area. When offset has not been considered, linearity of the system can be adversely affected as the target enters the offset region. The offset region also provides clearance for a moving target thereby preventing sensor/target contact. Sensor/Target contact could also cause sensor damage and contact errors in measurement.

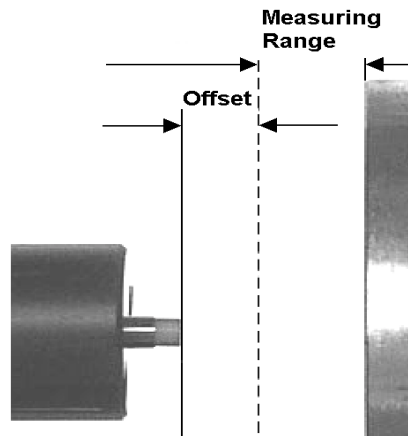

Figure 6. Offset and Measuring Range

Sensor range, linearity, or stability can be degraded if the sensor or target is not carefully installed. The following precautions should be considered:

- Avoid “secondary or side loading” target conductors. Surrounding metal to the side or the rear of the sensor coil can inductively couple with the target currents and thereby indirectly couple to the sensor coil. It is therefore best to keep conductors other than the target more than one coil diameter from the sensor coil.
- If temperature is not constant, avoid fixturing where thermal coefficients or thermal stresses contribute motion to the sensor location.

Part III: Calibration

System Calibration Record

All systems are factory calibrated and supplied with a record of factory testing. A calibration record, shown in figure 7, is obtained prior to shipment using a dimension standard (a micrometer fixture or laser measuring system) with a specified target material and configuration.

KAMAN INSTRUMENTATION CORPORATION 1500 GARDEN OF THE GODS ROAD COLORADO SPRINGS, COLORADO 80907 CUSTOMER SERVICE (719) 599-1919			
CALIBRATION RECORD			
CUSTOMER:		DATE: 12-Aug-97	
CUSTOMER P.O.#		SYSTEM SN:	
KAMAN SALES ORDER NO:		SENSOR SN:	
SYSTEM MODEL NO: SMU 9000-15N		P/N: 853834-014	
DISPLACEMENT MILS	OUTPUT VOLTS	LEAST SQUARES FIT VOLTS	NON-LINEARITY % FSO
0.00	0.000	0.001	-0.05%
1.00	0.248	0.252	-0.17%
2.00	0.501	0.503	-0.08%
3.00	0.753	0.754	-0.03%
4.00	1.005	1.004	0.02%
5.00	1.261	1.255	0.23%
6.00	1.512	1.506	0.24%
7.00	1.762	1.757	0.21%
8.00	2.008	2.008	0.02%
9.00	2.258	2.258	-0.02%
10.00	2.500	2.509	-0.37%

SUPPLY VOLTAGE (VOLTS): + 15
TARGET MATERIAL: CUSTOMER SUPPLIED ANODIZED ALUMINUM
TARGET CURVATURE: FLAT
CABLE LENGTH (INCHES): 15
CALIBRATION OFFSET (MILS): 25
NOTES: V_{out} @ -10 mils = -2.243 @ flush = -3.927

Figure 7. System Calibration Record

The SMU-9000 will have maximum accuracy only if the sensor is installed with the identical target configuration used in the

calibration process. The non-linearity of a system is calculated using the least square method which represents error from a best fit line through the data. When a specified range is less than 10% of the sensor coil diameter, a linear output of less than $\pm 5\%$ is usually possible. For sensors with a larger “percentage-of-diameter” calibrated range, 5th order coefficients of the natural curvature can be provided upon request. By using this polynomial correction with a computer or calculator program, linearity performance of approximately 0.1% or better can be achieved (see Figure 12).

Standard Calibration (Single Channel)

Calibration is a means to verify that system output relates to some known physical displacement, a reference, or dimensional standard with a known degree of accuracy. The accuracy of the dimensional standard will directly affect the accuracy of calibration, and thus the accuracy of any measurements taken. Standard calibration produces an output voltage that varies from a minimum desired output voltage when the target is closest to the sensor (plus offset) to some maximum positive voltage when the target is furthest from the sensor.

The SMU-9000 has two controls located inside the electronics enclosure labeled “Zero” and “Gain” as shown in Figure 8. To access these controls, remove the top cover.

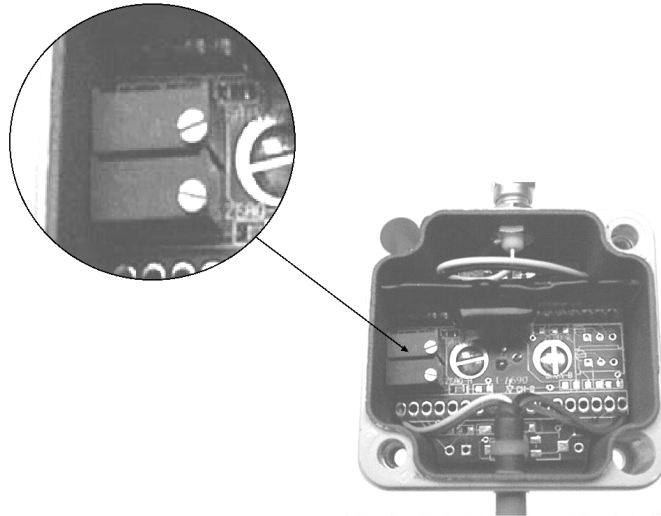

Figure 8. Zero and Gain Controls

During calibration, the controls will interact with each other. Because of this interaction, several iterations of a particular procedure will have to be performed before a system is calibrated.

Interaction between the controls should decrease with each iteration. To calibrate the system:

1. Position the target at the minimum displacement from the sensor (offset distance). Adjust the “Zero” control until the system output voltage reads zero or the minimum output voltage desired.
2. Position the target at the maximum displacement from the sensor (offset distance plus full range). Adjust the “Gain” control until the system output voltage reads the maximum output voltage desired.
3. Repeat steps 1 and 2 until the system output is calibrated.

Differential Calibration

Although the SMU-9000 does not offer a true differential output, a differential calibration is still possible with two channel and four channel systems. Sensor installation in this case is similar to that of the single channel configuration with an offset region and measurement range established for each sensor. An illustration of a typical differential calibration setup is shown in Figure 9.

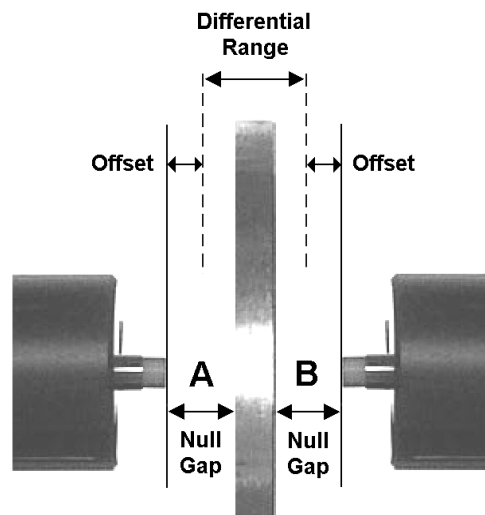

Figure 9. Differential Calibration Setup

With this type of calibration, the measurement range is shared by two sensors and is referred to as the differential range. For example, when one sensor is positioned at maximum displacement

from the target, the second sensor would therefore be positioned at minimum displacement respectively.

Differential Output Measurements

In a differential calibration, each channel of the SMU-9000 is calibrated individually. After calibrating each channel, a “balanced to ground” output is taken from the two the positive labeled output wires in order to display the differential output voltage. To accomplish this, connect the positive output wires to a voltmeter as shown in Figure 10.

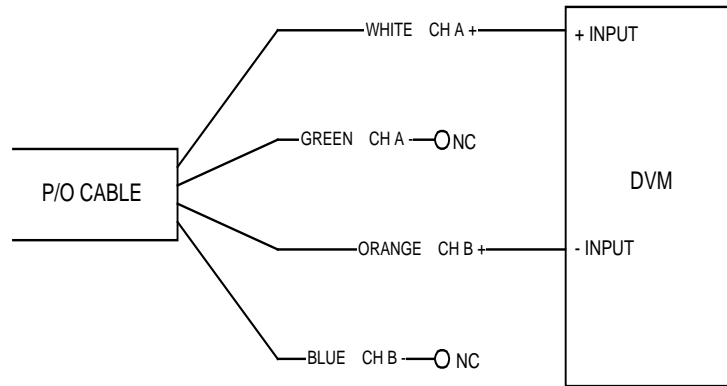

Figure 10. Differential output wire connections

This “balanced ground” connection allows the output of one channel to be subtracted from the other, producing a differential voltage reading at the voltmeter. For example, the differential output voltage measurements of a system calibrated using this method may look similar to the following:

Channel A Output	Channel B Output	Ch. A - Ch. B
0 V	+10 V	-10 V
+6.3 V	+6.3 V	0 V
+10 V	0 V	+10 V

Table 2. Differential Output Readings

Laser Calibration for Small Ranges

The SMU-9000 can be used to measure ranges as small as 0.001 inches with precision and accuracy. For small measurements such as this, Kaman uses a laser measuring system for final calibration. Calibration using this degree of precision is recommended for ranges less than 0.004 inches.

Bipolar Calibration

When performing this type of calibration procedure, the output voltage will range from a negative voltage for the first half of the measuring range to a positive output for the second half of the range. The “Zero” and “Gain” controls will interact with each other more than normal with this type of calibration. Consequently, the calibration process will be more iterative.

There are two methods that can be utilized to perform a bipolar calibration. A basic calibration with both end points being equal (absolute values) or an alternate calibration that produces a “Zero” output voltage reading at the mid point of the measuring range. Either method may be used depending on the user’s preference. Sample calibration record plots of output voltage versus displacement for each method of calibration is shown in Figure 11. Note that the plot of the data points in the basic bipolar calibration chart do not intersect the x-y axis exactly at zero as it does in the alternate bipolar calibration chart.

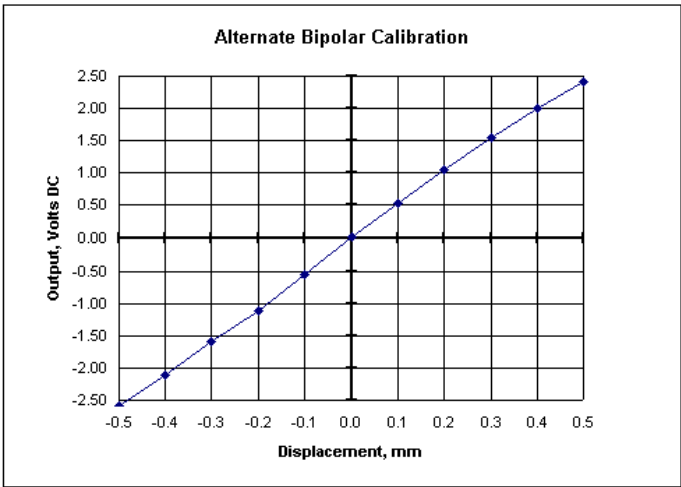
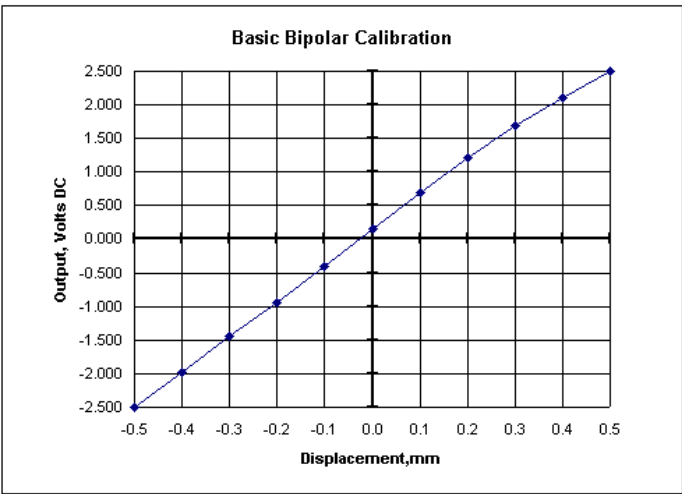

Figure 11. Bipolar Calibration Charts (Output vs. Displacement)

Basic Bipolar Calibration Method

1. Position the target at the minimum displacement from the sensor. Adjust the “Zero” control until the system output voltage reads the negative output voltage desired.
2. Position the target at the maximum displacement from the sensor. Make note of the actual output voltage reading. (The output voltage at this point will probably be greater than the desired full-scale output voltage).
3. Adjust the “Gain” control until the difference between the actual reading and desired reading is halved. For example, if the actual output reading was +6.000 Vdc and the desired reading was +5.000 Vdc, the “Gain” control would be adjusted to produce an output that is halfway to the desired output voltage or + 5.500 Vdc in this case. After several iterations, the actual output voltage reading will be closer to the desired reading.
4. Repeat steps 1 to 2 until the system is calibrated.

Alternate Bipolar Calibration

1. Position the target at the mechanical middle or mid-point of the measuring range and adjust the “Zero” control until the output voltage reads 0 Vdc. Further adjustment of the “Zero” control should not be necessary.
2. Position the target at the minimum displacement from the sensor. Adjust the “Gain” control to read the desired negative output voltage.
3. Position the target at the maximum displacement from the sensor and make a note of the actual output voltage reading.
4. Adjust the “Gain” control until the difference between the actual reading and the desired reading is halved. For example, if the actual output voltage reading was +2.400 Vdc at maximum displacement and the desired reading was +2.500 Vdc, the “Gain” control would be adjusted to produce an output that is halfway to the desired output voltage or +2.450 Vdc in this case.
5. The difference (absolute value) between the actual and the desired output voltage readings at each end point will be approximately equal. Using the previous example, the output voltage would read -2.550 Vdc at minimum displacement; 0Vdc at mid-point; and +2.450 Vdc at maximum displacement.
6. System calibration should be complete at this point

Part IV: System Performance

Linearity and Temperature Performance

Typically, the SMU-9000 will yield the best linearity performance over smaller ranges. As the measuring range is increased, the linearity of the system will decrease. For example, a sensor set up for a measuring range equal to about 5% of its diameter against a non-magnetic target will be about 1% non-linear. Increasing the measuring range to 10% of the sensor's diameter against the same target, will produce a non-linearity of approximately 5%. Further increasing the measuring range of the system to about 30% of the sensor's diameter will produce a non-linearity from 15% to 20%.

In general, systems with the best linearity will not yield the best thermal stability. For example, a system with a non-linearity of approximately 1% will typically have a thermal stability of 0.1%. However, non-linearity will increase as the system is optimized for thermal stability. In this case, a system that is optimized for 0.05% thermal stability may result in a non-linearity of approximately 10%.

Fifth order polynomial curve fit linearity coefficients can be provided for use in customer processors to achieve linearity performance of approximately 0.1% or better. The polynomial curve fit is applied to the linearity data and the result is a corrected linearity. An example of this is shown in Figure 12.

KAMAN INSTRUMENTATION
 1500 GARDEN OF THE GODS ROAD
 COLORADO SPRINGS, COLORADO 80907
 CUSTOMER SERVICE (719) 599-1919

POLYNOMIAL CORRECTED CALIBRATION RECORD

CUSTOMER: _____ DATE: 16-Apr-97

CUSTOMER P.O.# _____ SYSTEM SN: _____
 KAMAN SALES ORDER NO: _____ SENSOR SN: _____
 SYSTEM MODEL NO. SMO 9000-3U1 CHANNEL # _____

DISPLACEMENT MILS	OUTPUT VOLTS	CALCULATED DISPLACEMENT	ERROR IN MILS
0.00	-4.996	-0.010	-0.010
8.00	-3.297	8.059	0.059
16.00	-1.631	15.872	-0.128
24.00	-0.131	24.089	0.089
32.00	1.117	32.068	0.068
40.00	2.146	39.950	-0.050
48.00	2.979	47.900	-0.100
56.00	3.650	55.978	-0.022
64.00	4.195	64.138	0.138
72.00	4.630	72.014	0.014
80.00	5.002	79.943	-0.057

5th Order Polynomial

$$\text{Mils} = a_0 + a_1x + a_2x^2 + a_3x^3 + a_4x^4 + a_5x^5$$

a₀ = 2.487104E+1
 a₁ = 6.009417E+0
 a₂ = 3.353680E-1
 a₃ = 3.312125E-2
 a₄ = 1.068288E-2
 a₅ = 1.848772E-3

Figure 12. Calibration Record with Polynomial correction

Resolution

Resolution for three typical SMU-9000 systems are shown in Figures 13, 15 and 17. Care should be taken in order to achieve the resolution desired, particularly in fixturing and filtering. The noise measurements, as a function of bandwidth, include external filtering. The graphs represent the peak-to-peak noise and peak-to-peak noise per root hertz at various bandwidths as measured with a differential oscilloscope (Noise Density).

SMU 9000-15N (10KHz Bandwidth)

Offset: .004"

Range: .002"

Output: 10V

Target: Aluminum

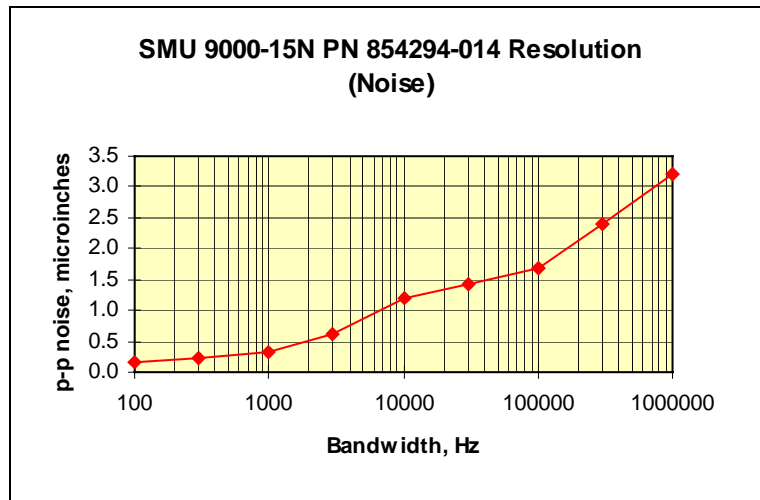

Figure 13. SMU 9000-15N Resolution

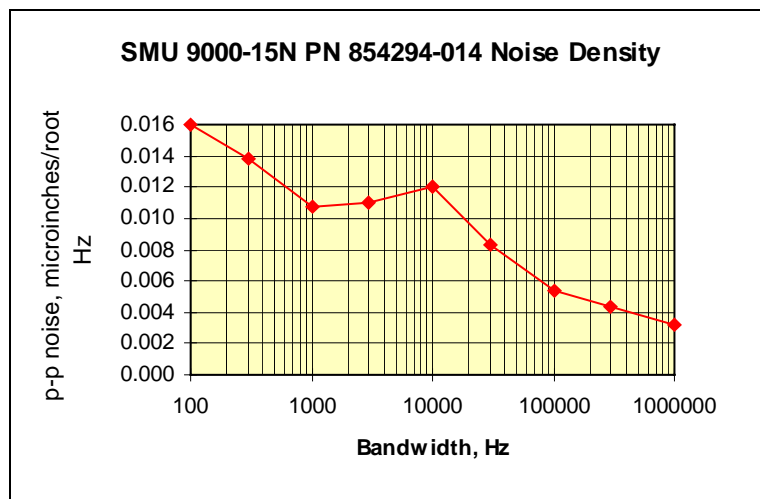

Figure 14. SMU 9000-15N Noise Density

SMU 9000-15N 2KHz Bandwidth

Offset: .010"

Range: .022"

Output: 10V

Target: Aluminum

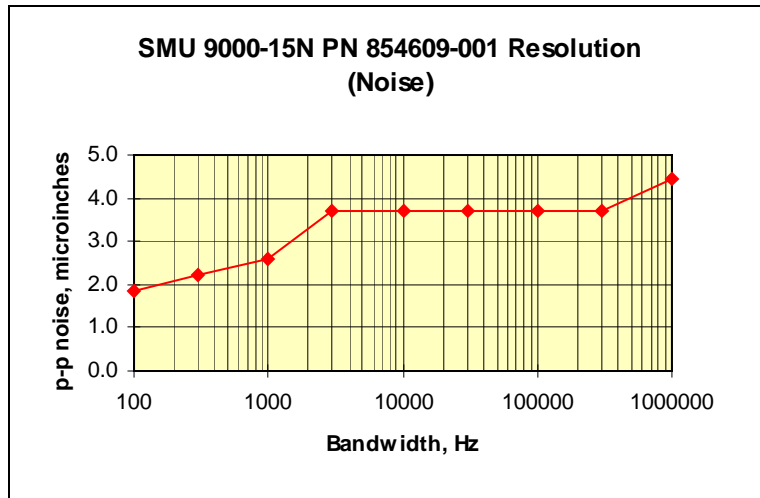

Figure 15. SMU 9000-15N Resolution

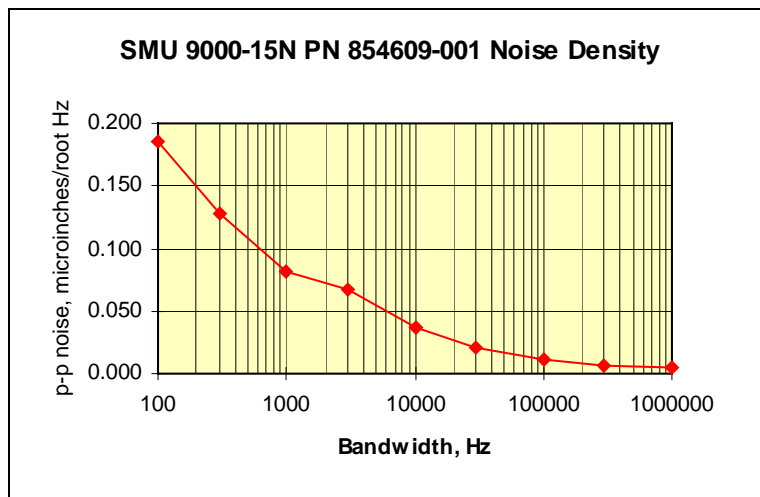

Figure 16. SMU 9000-15N Noise Density

SMU 9000-25U W/1 KHz Low Pass Filter

Offset: .040"

Range: .200"

Output: 10V

Target: Nickel Plated Aluminum (2-3 mils of plating)

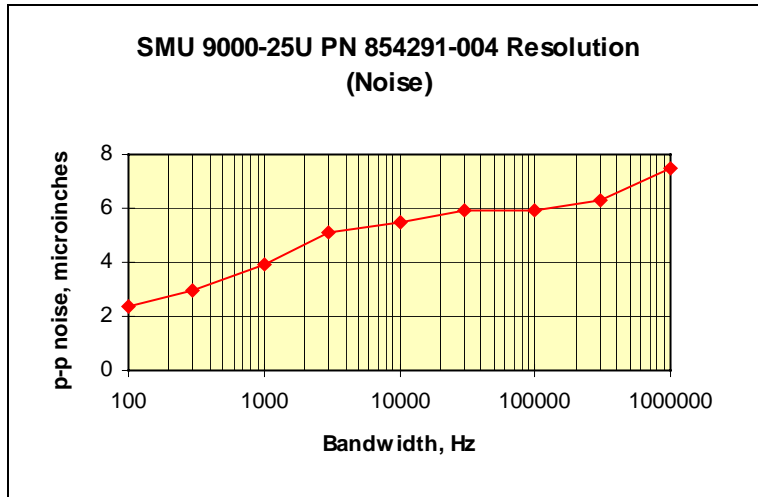

Figure 17. SMU 9000-25U Resolution

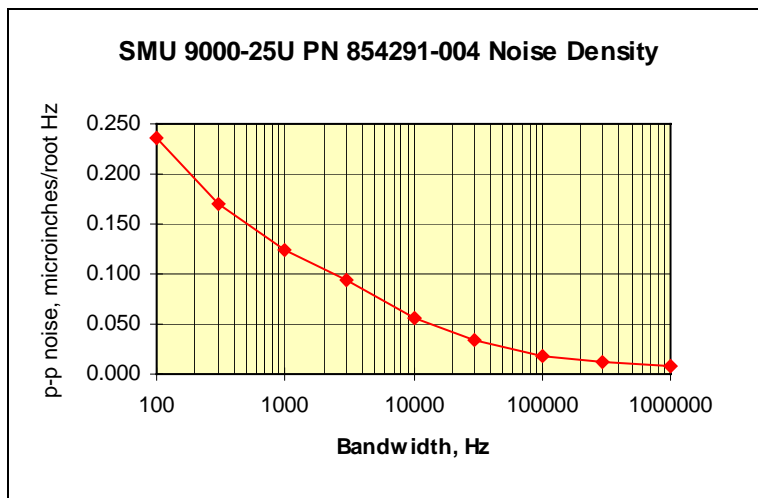

Figure 18. SMU 9000-25U Noise Density

Applications Summary

The SMU-9000 is versatile enough to satisfy the most demanding OEM performance and packaging requirements for non-contact position measuring systems in a wide range of applications. The cost effective SMU-9000 provides the user extremely high measurement performance which is customizable to the application. These are a few of the many applications where the SMU-9000 is operating today.

Stage Position Measurement and Alignment Applications

- Optical alignment systems
- Liquid crystal display manufacturing equipment
- Semiconductor mask alignment for step and repeat systems
- Scanning electronic microscope - vertical axis positioning
- Atomic force microscopy - vertical axis positioning

Polishing and Grinding Manufacturing Applications

- Thickness and position measurement for disk drive, semiconductor wafers, and optics
- Fine positioning for parts grinding and precision machining

Mirror Positioning

- Mirror steering for pointing and tracking systems
- Vibration suppression and control systems

Material Testing and Data Collection Applications

- Material compression testing
- Mechanical structure creep detection

Miscellaneous

- Arthroscopic surgical console over-pressure warning
- Chemical vapor deposition (CVD) system set up and alignment verification
- Magnetic bearing suspension control systems
- Aircraft rivet height inspection

Part IX: Warranty

Kaman Precision Products Standard Limited Warranty

Products of Kaman Precision Products are warranted to be free from defects in materials and workmanship when installed and operated in accord with instructions outlined in the instruction manual.

Kaman Precision Products' obligation under this warranty shall be limited to repair or replacement (at the discretion of Kaman Precision Products) of the defective goods returned to Kaman's plant within one (1) year from date of shipment. Extreme environment sensors are limited to the maximum operating temperature as specified within the most current Kaman Measuring Systems Extreme Environment Systems data sheets.

This warranty is valid except when the products have been subject to misuse, accident, negligent damage in transit or handling, or operation outside the conditions prescribed in the data sheet or instruction manual. This will be determined by Kaman Instrumentation personnel.

In no event shall Kaman be liable for incidental or consequential damages, including commercial loss, resulting from any article sold under this Agreement.

In the event Buyer fails to limit to Kaman's warranty set forth above, any express or implied warranty Buyer may make with respect to any product of which any article sold thereunder is a component, Buyer shall indemnify and hold Kaman harmless from any and all liability, costs and expenses to which Kaman may be subjected as a result of Buyer's failure to so limit its express or implied warranties.

THIS WARRANTY IS EXCLUSIVE AND IS MADE IN LIEU OF ALL OTHER WARRANTIES; AND THOSE IMPLIED WARRANTIES, INCLUDING SPECIFICALLY THE WARRANTIES OR MERCHANTABILITY AND FITNESS FOR A PARTICULAR PURPOSE ARE HEREBY EXPRESSLY LIMITED TO ONE (1) YEAR DURATION.

NO MODIFICATION OR ALTERATION OF THE FOREGOING WARRANTY AND LIMITATION OR REMEDIES PROVISIONS SHALL BE VALID OR ENFORCEABLE UNLESS SET FORTH IN A WRITTEN AGREEMENT SIGNED BY KAMAN AND THE BUYER.

Kaman Instrumentation Warranty No. 7A

Customer Service Information

Should you have any questions regarding this product, please contact an applications engineer at **Kaman Precision Products Operations** 719-635-6979 or fax 719-634-8093. You may also contact us through our web site at www.kamansensors.com.

Service Information

In the event of a malfunction, please call for return authorization:

Customer Service/Repair **Kaman Precision Products Operations:**

860-632-4442